

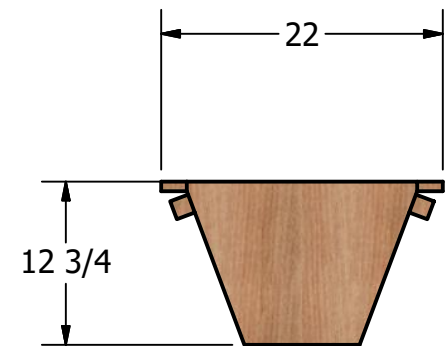

Top Bar Beehive

Overall Dimensions

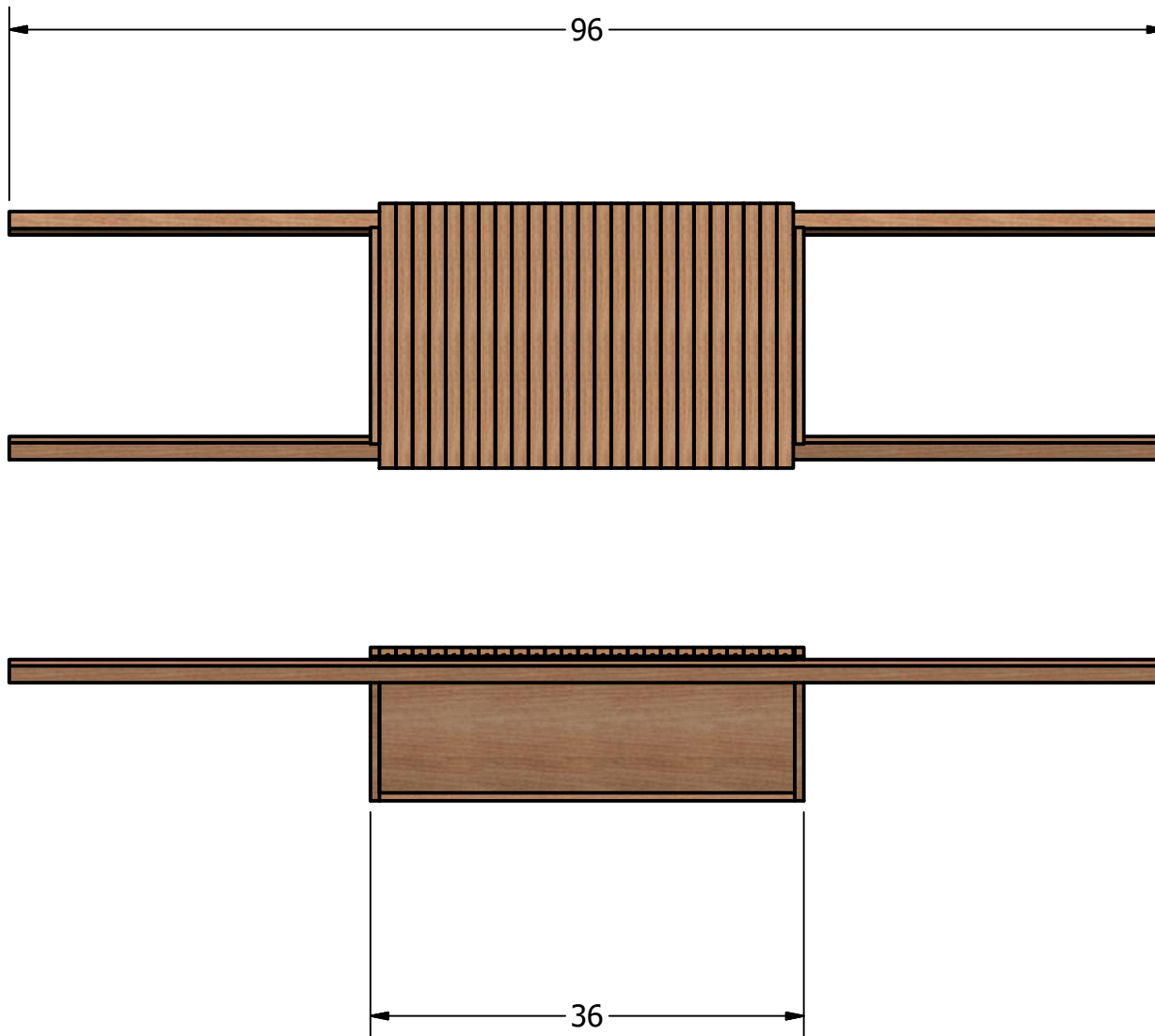

End Plates

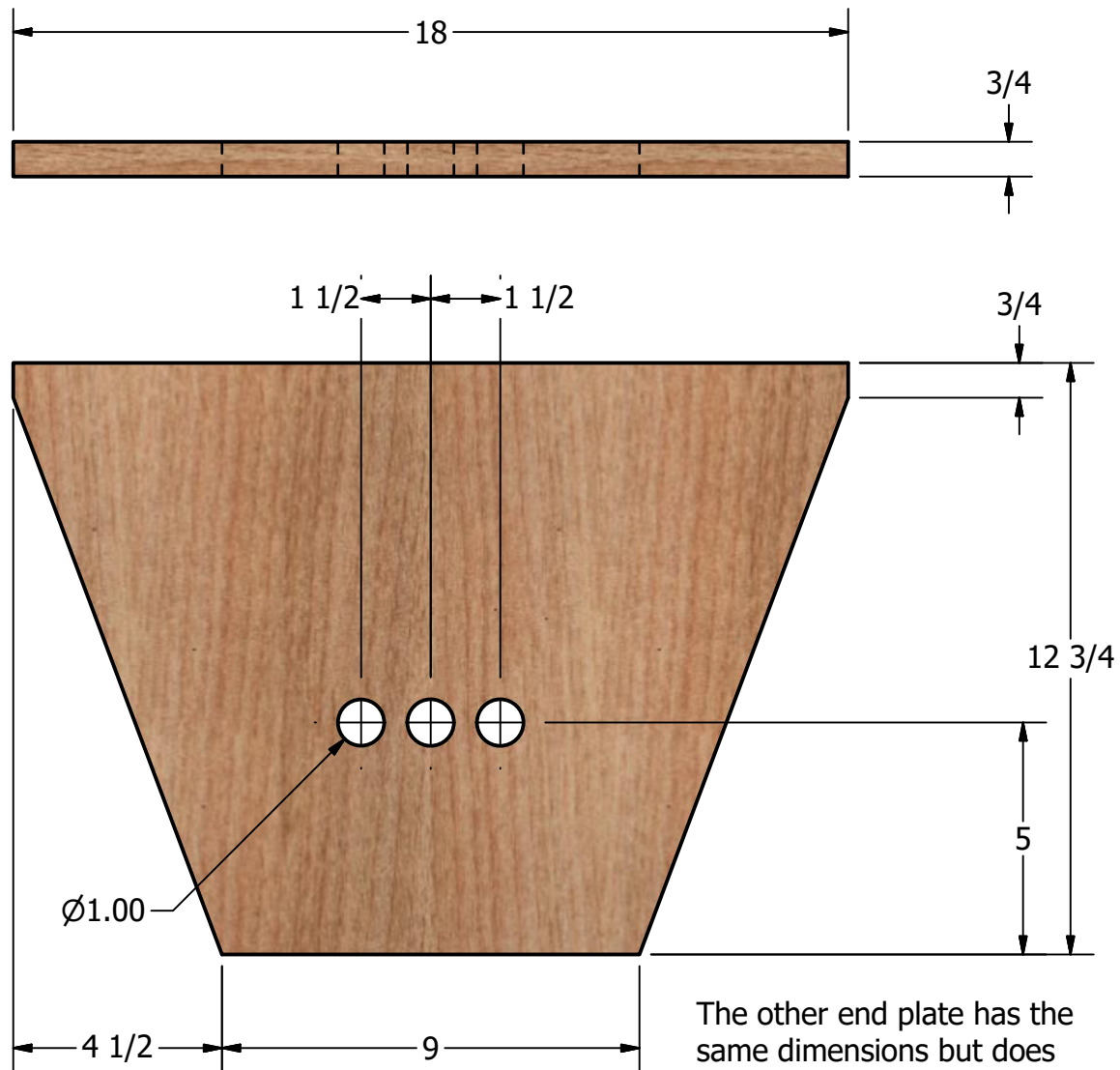

The other end plate has the same dimensions but does not need the holes

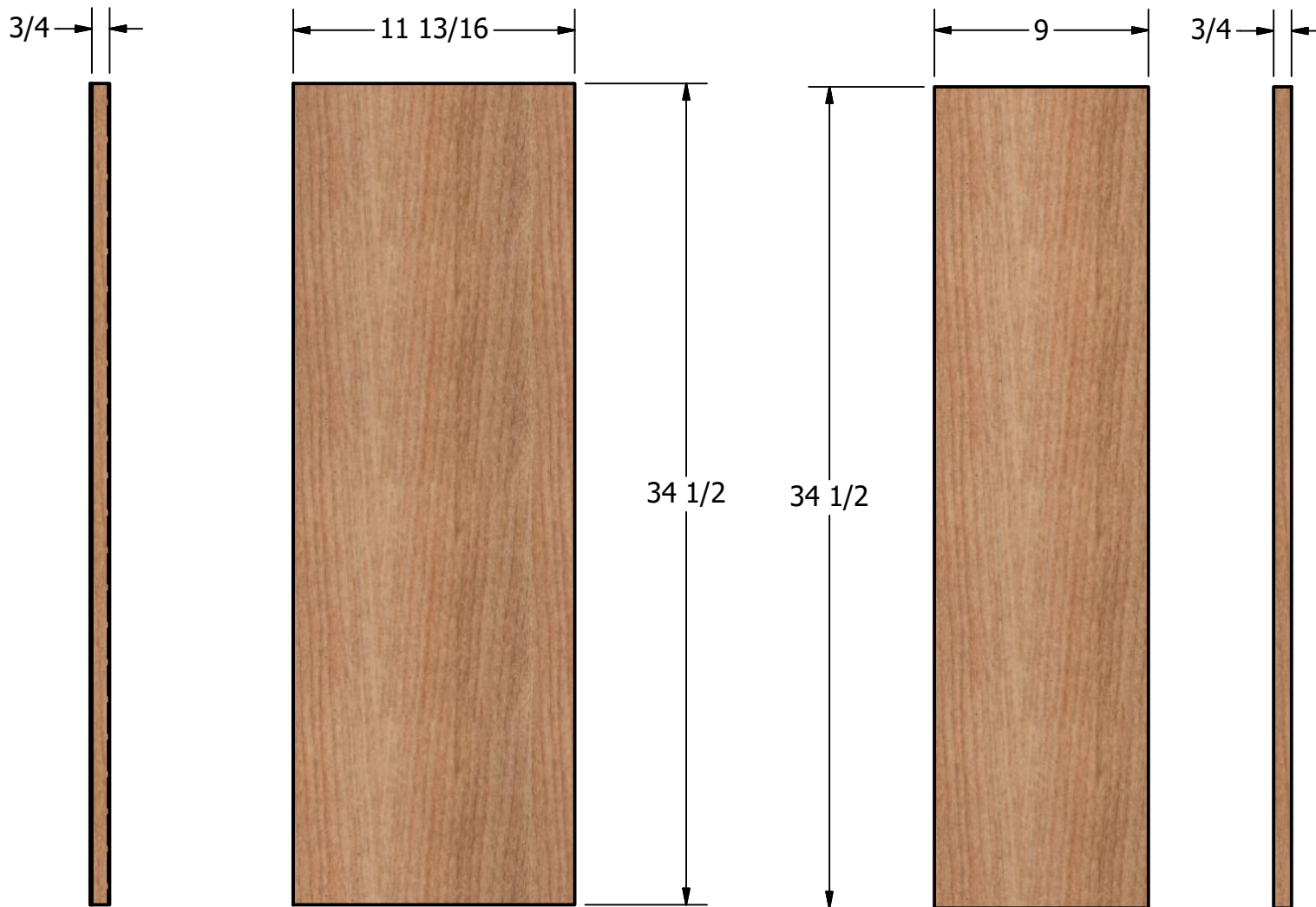

Walls (2 of these)

Bottom Plate

Top Bars

For this design you will need 25 of these bars.
I cut the slot running down the middle with a table saw.

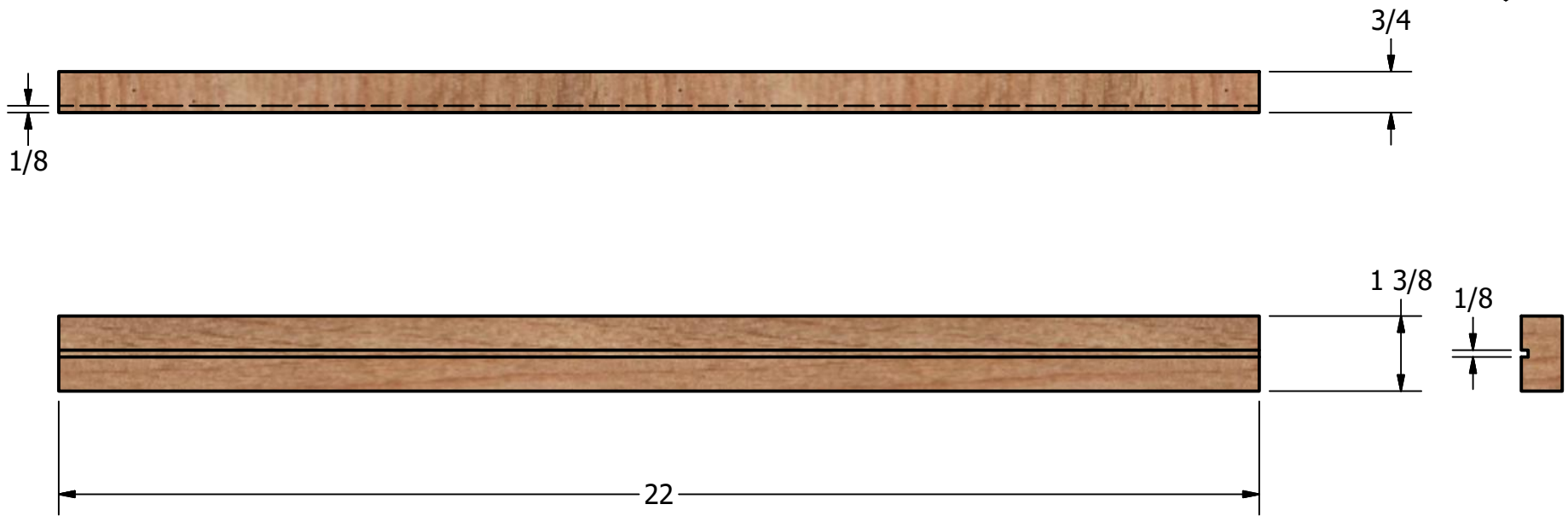
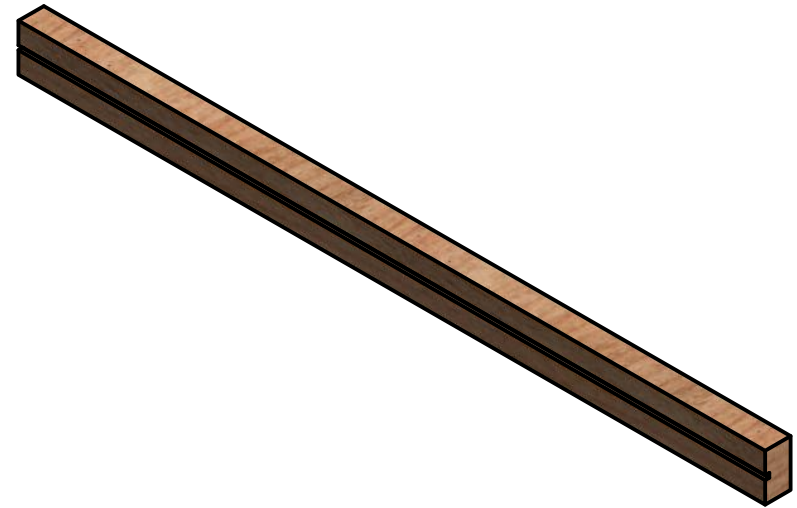

Handles

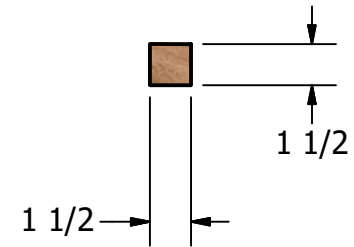
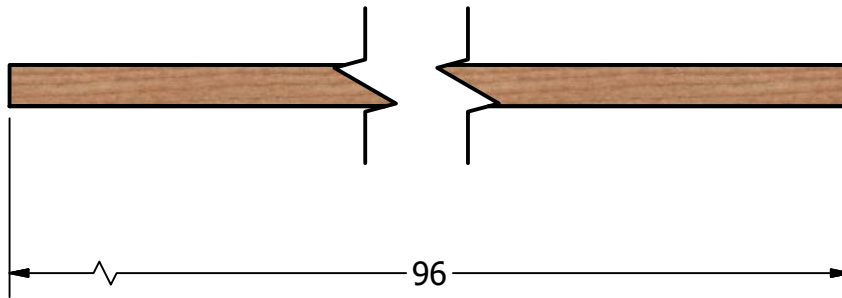

Materials

You need one 4x4x3/4" piece of plywood, two 2x2x8 and six pieces of the 1 1/8" x 3/4" x 8 ft lumber for the top bars.

Assembly

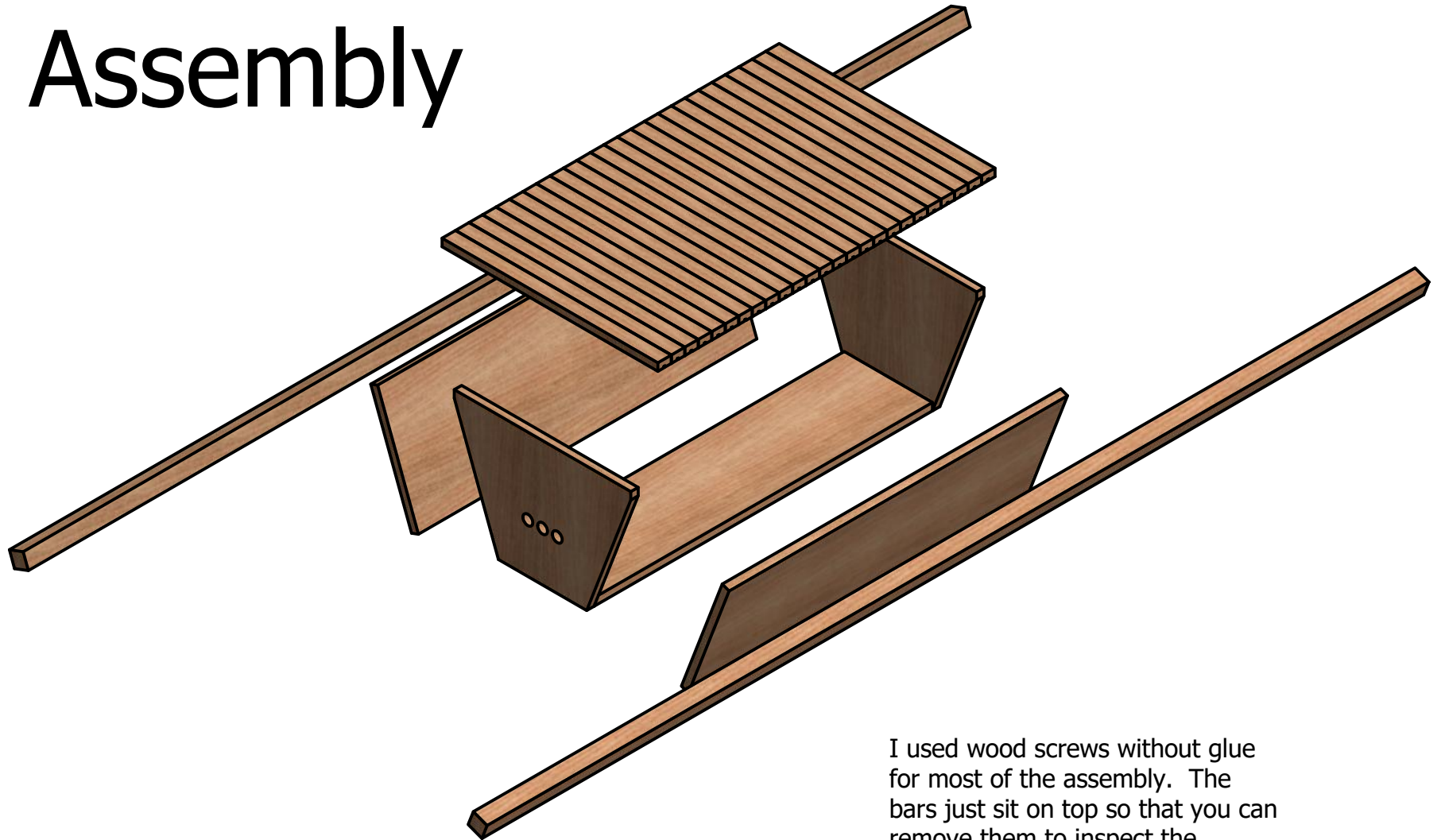

I used wood screws without glue for most of the assembly. The bars just sit on top so that you can remove them to inspect the combs.